

# Appendix B Built Form Capacity Study

2016



## Contents

---

	Glossary of terms	4
<b>1</b>	<b>Introduction</b>	<b>7</b>
	Introduction	9
	Methodology	9
<b>2</b>	<b>Analysis</b>	<b>11</b>
	Formula	12
	Floor space efficiency	13
	Description of the capacity formula	16
<b>3</b>	<b>Results</b>	<b>21</b>
	Results	22
	Conclusion	33
	Limitations	33

## Glossary of terms

The following are terms and abbreviations commonly used throughout this study:

Code	Translation	Description	Formula (if applicable)
AMPH	Average maximum potential height	Average maximum potential height - Expressed as an RL - determined by Sun Access Planes (SAP), No Additional Overshadowing (NAO) controls and aeronautical PANS OPS surfaces)	
EMFS	Existing Maximum Floor Space	Existing maximum floor space under SLEP 2012	
FSE	Floor Space Efficiency		
FSES	Floor Space Employment Survey	Floor Space Employment Survey conducted by the City of Sydney in 2012	
FSES_FS	Floor Space Counted from the Floor Space Employment Survey	Floor Space Counted on the same block extent from the Floor Space Employment Survey conducted by the City of Sydney in 2012	
HE	Height Efficiency	percentage of a counted floor (supporting floor space) per metre of height	
High TVE	High Tower Volumetric Efficiency	derived by multiplying the height efficiency by the high horizontal efficiency	High TVE=HE x MOD_E
HIGH_E	High Efficiency	a percentage of floor space efficiency derived through a series of reductions for elevational tapering, articulation, facade and cores	62.30%
HSE	Horizontal Sectional Efficiency	floor space per counted floor	If PHC= PANS OPS then RCZ = 30m
MH_AGL	Maximum Height Above Ground Level	The maximum height above ground level across the site, derived by subtracting the site ground level from the average maximum potential height.	MH_AGL = AMPH - SGL
MOD_E	Moderate Efficiency	a percentage of floor space efficiency derived through a series of reductions for elevational tapering, articulation, facade and cores	51.30%
Moderate TVE	Moderate Tower Volumetric Efficiency	derived by multiplying the height efficiency by the moderate horizontal efficiency	Moderate TVE=HE x MOD_E
MTZA	Maximum Tower Zone Area	the greatest area that a tower zone can be	4000m <sup>2</sup>
NAO	No Additional Overshadowing	building height control defined by fans that protect sunlight access to open spaces	
NAO AUS SQ		No Additional Overshadowing Fan Protecting Australia Square	
NAO MACQPL		No Additional Overshadowing Fan Protecting Macquarie Place	
NAO MP		No Additional Overshadowing Fan Protecting Martin Place	
NAO PSM		No Additional Overshadowing Fan Protecting Pitt Street Mall	
NAO THS		No Additional Overshadowing Fan Protecting Town Hall Square	

Code	Translation	Description	Formula (if applicable)
PANS OPS		Procedures for air navigation services – aircraft operation	
PFS	Podium Floor Space	derived by multiplying the podium zone volume by the podium volumetric efficiency	$PFS = PZV \times PVE$
PHC	Prevailing Height Control	the height control that affects the site at the lowest height above ground level	
PVE	Podium Volumetric Efficiency	derived by multiplying the height efficiency by the high horizontal efficiency	$PVE = HE \times HIGH\_E$
PZA	Podium Zone Area	Area taken up by the podium - Equal to the site area	$PZA = SA$
PZH	Podium Zone Height	The assumed height of the Podium Form	$PZH = 25m$
PZV	Podium Zone Volume	derived by multiplying the podium zone area (PZA) by the podium zone height (PZH)	$PZV = PZA \times PZH$
RCZ	Roof Construction Zone	15m where the development height is limited by a sun control and 30m where it is limited by the PANS OPS	If PHC= NAO or SAP then RCZ = 15m
SA	Site area	Site Area	
SAP	Sun Access Plane	building height control defined by planes that protect sunlight access to open spaces	
SAP BELPK		Sun Access Plane Protecting Belmore Park	
SAP DH		Sun Access Plane Protecting Darling Harbour	
SAP HP		Sun Access Plane Protecting Hyde Park	
SAP MP		Sun Access Plane Protecting Martin Place	
SAP WYN PARK		Sun Access Plane Protecting Wynyard Park	
SGL	Site Ground Level	Highest site ground level - Expressed as an RL	
SP	Site Perimeter	Site Perimeter	
TFS	Tower Floor Space	derived by multiplying the tower zone volume (TZV) by the tower volumetric efficiency (TVE)	$TFS = TZV \times (\text{high TVE or moderate TVE})$
TOTAL_FS High			
TOTAL_FS Moderate	Total Floor Space	derived by adding the podium floor space (PFS) and tower floor space (TFS, high and moderate) values together	$TOTAL\_FS = PFS + TFS$
TZA	Tower Zone Area	derived by taking the site area (SA) and subtracting the site perimeter (SP) multiplied by the average required setback (ARS) of 8m from the height, setbacks and massing policy and then adding a constant (C) of 256 to account for the double subtraction at corners of the site	$TZA = SA - (SP \times ARS) + C$
TZH	Tower Zone Height	derived by taking the average maximum potential height (AMPH) and subtracting the highest site ground level (SGL), the podium zone height (PZH) and a roof/construction zone (RCZ)	$TZH = AMPH - SGL - PZH - RCZ$
TZV	Tower Zone Volume	derived by multiplying the tower zone area (TZA) by the tower zone height (TZH)	$TZV = TZA \times TZH$
VE	Volumetric Efficiency	Taken together the height efficiency multiplied by the horizontal sectional efficiency yield a volumetric efficiency.	$VE = HE \times HSE$
	Potential Amalgamation		



# 1

## Introduction

---





## Introduction

This capacity study sets out potential floor space growth under the proposed growth strategy where building heights are limited by sun and airport controls and maximum floor space is aligned with height and other built form controls.

## Methodology

The capacity calculation methodology developed in this report has three main steps:

1. Identify potential sites that could be amalgamated to create additional capacity within the city
2. Calculate potential high and moderate floor space growth scenarios
3. Compare the identified site yields with existing controls



## 2

### Analysis

---

## Formula

The potential floor space growth is calculated by making generic assumptions about floor space efficiency within the permitted tower zone that relates to setbacks required under the strategy. The tower Zone is calculated using a Formula

The main inputs into the formula are:

- Site area (SA)
- Site perimeter (SP)
- Highest site ground level (SGL, expressed as an RL)
- Average maximum potential height (AMPH, expressed as an RL – determined by Sun Access Planes (SAP), No Additional Overshadowing (NAO) controls and aeronautical PANS OPS surfaces)

The tower zone volume is multiplied by a development efficiency to calculate floor space.

- The floor space efficiency incorporates:
  - *Height efficiency* – percentage of a counted floor (supporting floor space) per metre of height
  - *Horizontal sectional efficiency* – floor space per counted floor

Taken together the *height efficiency* multiplied by the *horizontal sectional efficiency* yield a *volumetric efficiency*.

## Floor space efficiency

### Height efficiency

*Height efficiency* reflects the number of floors containing floor space within a given height in metres converted to the abstract equivalent percentage of a single floor containing floor space in a single metre of height.

It is assumed that for every 20 commercial floors at a floor to floor height of 3.85m that there will be a plant level with no floor space attributed of 6m height (Illustrated in B\_01). This yields a floor containing floor space on average every 4.15m or 24.1% of a single floor containing floor space for every metre of height of the *tower/podium zone volume* (i.e. the inverse  $24.1\% = 1/4.15$ ).

### B\_01

Height Efficiency - General Commercial Section

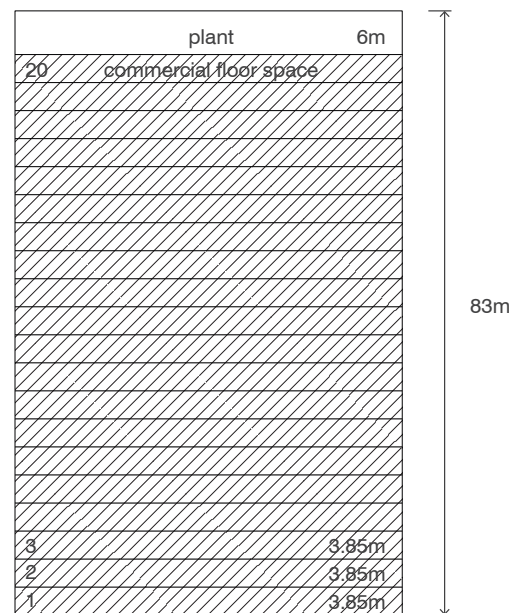

### Horizontal sectional efficiency

*Horizontal sectional efficiency* reflects the amount of floor space expected on a floor containing floor space within the horizontal area of the *tower/podium zone volume* (refer to B\_02 and B\_03).

It is assumed that the amount of floor space reflects a compounding series of reductions as described in B\_05 and illustrated in B\_04.

#### B\_02

Horizontal section through the tower volume

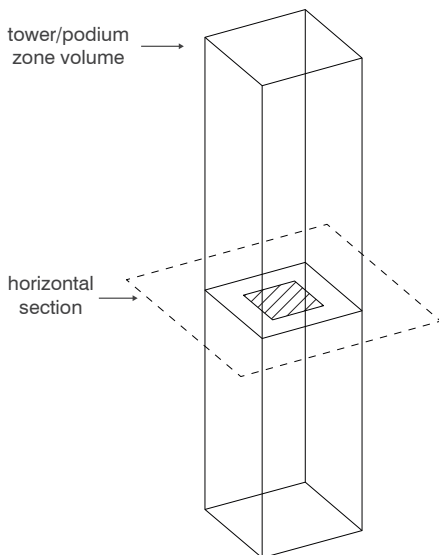

#### B\_03

Section representing a notional floor

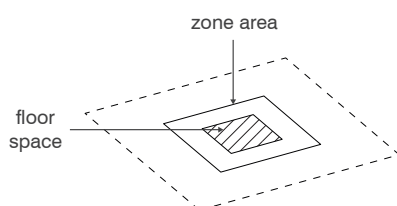

### Volumetric efficiency

The *volumetric efficiency* is given by multiplying the *height efficiency* by the *horizontal sectional efficiency*.

The *podium volumetric efficiency (PVE)* is derived by multiplying the *height efficiency* by the *high horizontal efficiency*, i.e. 24.1% times 62.3% is equal to **15%**.

The *high tower volumetric efficiency (high TVE)* is derived by multiplying the *height efficiency* by the *high horizontal efficiency*, i.e. 24.1% times 62.3% is equal to **15%**.

The *moderate tower volumetric efficiency (moderate TVE)* is derived by multiplying the *height efficiency* by the *moderate horizontal efficiency*, i.e. 24.1% times 51.3% is equal to **12.4%**.

**B\_05**

Floor Space within Zone Sectional Area

Description of reduction	Method of defining reduction
10% for elevational tapering	multiplier = 100% - 10% = 90%
30% building articulation for <i>moderate efficiency</i> or 15% building articulation for <i>high efficiency (and podiums)</i>	multiplier = 100% - 30% = 70%  multiplier = 100% - 15% = 85%
3% façade depth	multiplier = 100% - 3% = 97%
16% building core exclusions	multiplier = 100% - 16% = 84%
A <i>moderate efficiency</i> floor containing floor space therefore has an efficiency of 51.3%.	90% x <b>70%</b> x 97% x 84% = 51.3%
A <i>high efficiency</i> floor containing floor space where 15% is substituted for building articulation therefore has an efficiency of 62.3%.	90% x <b>85%</b> x 97% x 84% = 62.3%

**B\_04**

Floor Space within Zone Sectional Area

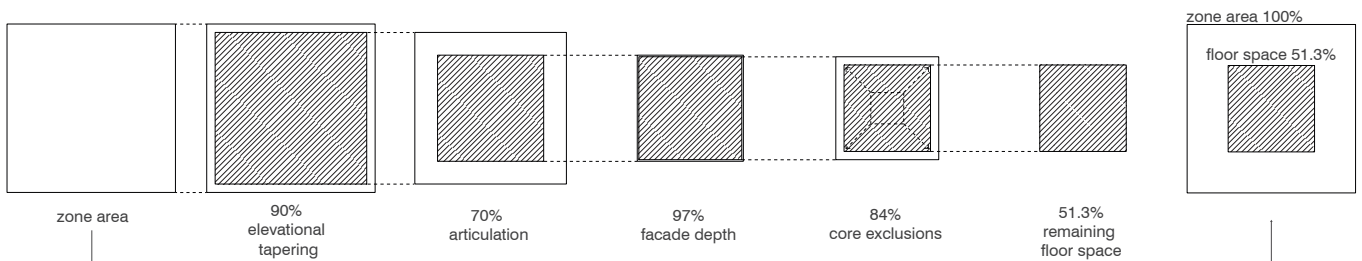

## Description of the capacity formula

The Podium	
The <i>podium zone area</i> (PZA) is equal to the <i>site area</i> (SA).	$PZA = SA$
The <i>podium zone height</i> (PZH) is assumed to be 25m.	$PZH = 25$
The <i>podium zone volume</i> (PZV) is derived by multiplying the <i>podium zone area</i> (PZA) by the <i>podium zone height</i> (PZH). See B_06.	$PZV = PZA \times PZH$
The <i>podium floor space</i> (PFS) is derived by multiplying the <i>podium zone volume</i> (PZV) by the <i>podium volumetric efficiency</i> (PVE) assumed to be 15% (from above).	$PFS = PZV \times PVE$
	Substitution gives $PFS = (SA \times 25) \times 15\%$

### B\_06

Podium Zone height and area and Podium Zone Volume

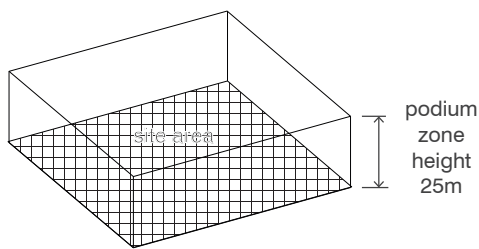

### B\_07

Elements of the formula

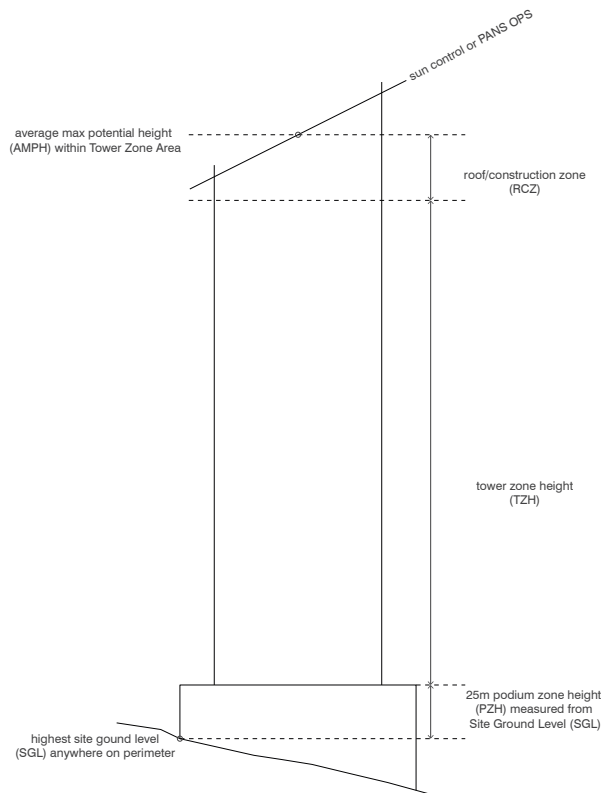



## The Tower

The area of the *tower zone area* (TZA) is derived by taking the *site area* (SA) and subtracting the *site perimeter* (SP) multiplied by the *average required setback* (ARS) of 8m from the *height, setbacks and massing policy* and then adding a *constant* (C) of 256 to account for the double subtraction at corners of the site. See B\_08.

$$TZA = SA - (SP \times ARS) + C$$

Substitution gives

$$TZA = SA - (SP \times 8) + 256$$

Testing indicates that this approach very strongly approximates the tower zone area as measured.

Where the *tower zone area* (TZA) is greater than the *maximum tower zone area* (MTZA) of 4,000m<sup>2</sup> the site is split into two sites (See B\_09). If the resulting two sites together yielded a greater total tower zone area then this value is used, otherwise the *maximum tower zone area* is used.

If  $TZA > MTZA$  (4000) then split into two sites (resulting in TZA1 and TZA2).

If  $TZA1 + TZA2 > MTZA$  (4000) then let  $TZA = TZA1 + TZA2$

Otherwise let  $TZA = MTZA = 4000$

The *tower zone height* (TZH) is derived by taking the *average maximum potential height* (AMPH) and subtracting the *highest site ground level* (SGL), the *podium zone height* (PZH) and a *roof/construction zone* (RCZ) that is 15m where the development height is limited by a sun control and 30m where it is limited by the PANS OPS. See B\_07.

$$TZH = AMPH - SGL - PZH - RCZ$$

Where  $PZH = 25$  from above

Where AMPH is limited by sun control(s) the result is

$$TZH = AMPH - SGL - 40$$

Where AMPH is limited by PANS OPS the result is

$$TZH = AMPH - SGL - 55$$

The *tower zone volume* (TZV) is derived by multiplying the *tower zone area* (TZA) by the *tower zone height* (TZH). See B\_10.

$$TZV = TZA \times TZH$$

The *tower floor space* (TFS) is derived by multiplying the *tower zone volume* (TZV) by the *tower volumetric efficiency* (TVE), high - 15% and moderate - 12.4% values are used to establish an expected range.

$$TFS = TZV \times TVE$$

Substitution gives

$$TFS = (SA - (SP \times 8) + 256) \times (AMPH - SGL - (40 \text{ or } 55)) \times (15\% \text{ or } 12.4\%)$$

### B\_08

Tower Zone Area

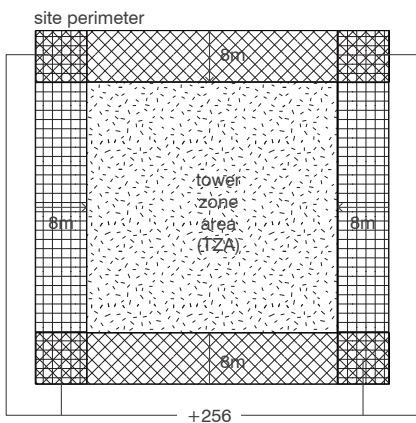

### B\_09

Tower Zone Areas over 4000m<sup>2</sup>

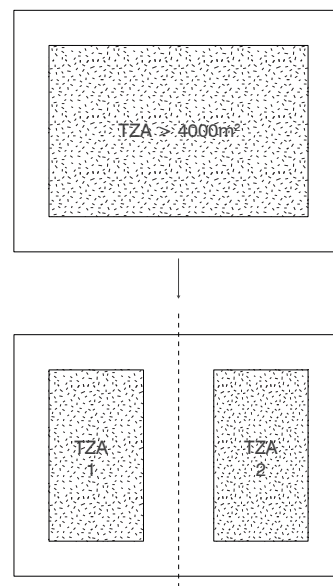

### B\_10

Tower Zone Volume

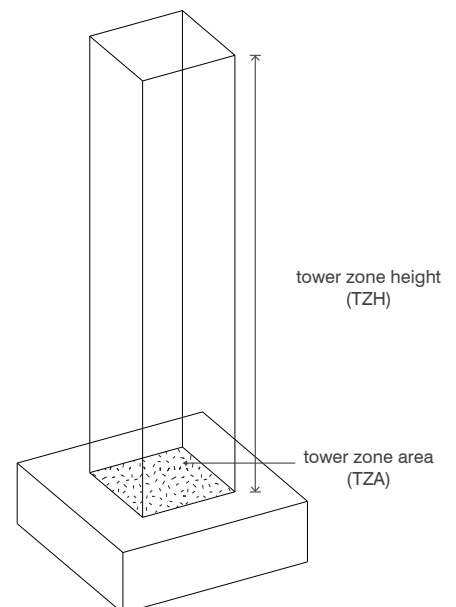

### Total Floor Space

The *total floor space* (TOTAL\_FS) in the development is derived by adding the *podium floor space* (PFS) and *tower floor space* (TFS, high and moderate) values together.

$$\text{TOTAL\_FS} = \text{PFS} + \text{TFS}$$

Substitution gives

$$\text{TOTAL\_FS} = ((\text{SA} \times 25) \times 15\%) + ((\text{SA} - (\text{SP} \times 8) + 256) \times (\text{AMPH} - \text{SGL} - (40 \text{ or } 55)) \times (15\% \text{ or } 12.4\%))$$





### 3

## Results

---

## Results

### Part 1 - Site Identification

Potential site amalgamations are identified that do not include:

- heritage items
- residential strata schemes (unless 50% of the scheme is in single ownership)
- very small sites isolated by one or more of the above and hence unable to amalgamate to a site able to develop a tower and provide required setbacks

See B\_11 for constrained sites. Potential Amalgamations are shown in B\_12 Site Identification.

Detailed site constraints can be found in Figures B\_18 to B\_20 at the end of this document.

**B\_11**

Constrained Sites Analysis

- Major Development
- Parks and Public Spaces
- Sydney LEP 2005
- Recent Development
- Isolated Sites
- Heritage Items



B\_12

Site Identification

- Precincts
- Potential Amalgamation
- X Block ID
- X Site Sub-Code

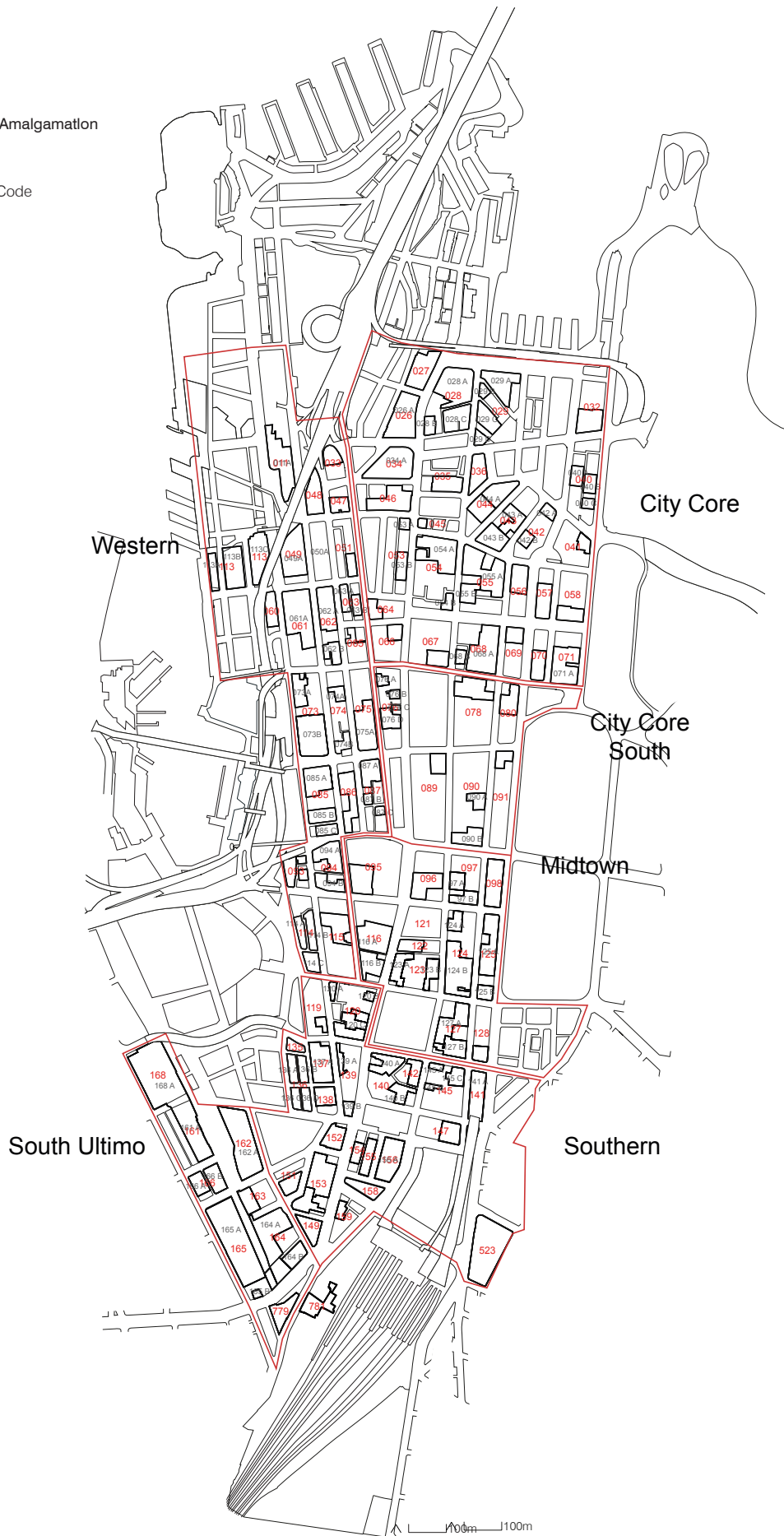



## Part 2 - Floor Space Growth Scenarios

The commercial development capacity of each identified site for is calculated using a generalised formula described previously.

The complete results are presented in B\_14.

The codes for Height Controls are explained in B\_13.

### B\_13

Explanation of Codes for Prevailing Height Controls

#### Sun Access Plane Controls (SAP)

Height Control Code	Height Control Name
SAP WYN PARK	Wynyard Park
SAP DH	Darling Harbour
SAP MP	Martin Place
SAP HP	Hyde Park
SAP BELPK	Belmore Park

#### No Additional Overshadowing Controls (NAO)

Height Control Code	Height Control Name
NAO THS	Town Hall Square
NAO AUS SQ	Australia Square
NAO MACQPL	Macquarie Place
NAO PSM	Pitt Street Mall
NAO MP	Martin Place

#### Airport Controls (PANS OPS)

Height Control Code	Height Control Name
PANS OPS	Procedures for air navigation services – aircraft operation

**B\_14**

Commercial Development Capacity of identified sites

Map Reference	Precinct	Site Area (sqm)	Site Perimeter (m)	Highest Site Ground Level (RL AHD)	Average Maximum Potential Height (RL AHD)	Maximum Height Above Ground (m)	Prevailing Height Control	Roof/ Construction Zone (m)	Tower Zone Area (sqm)	Total Floor Space High (sqm)	Floor Space Ratio High (X:1)	Total Floor Space Moderate (sqm)	Floor Space Ratio Moderate (X:1)
		SA	SP	SGL	AMPH	MH_AGL	PHC	RCZ	TZA	TOTAL_FS_high		TOTAL_FS_mod	
011 A	Western	7,860	525	4	254	250	SAP WYN PARK	15	3,912	152,417	19.4	131,107	16.7
48	Western	4,224	301	20	167	147	SAP WYN PARK	15	2,070	49,057	11.6	43,299	10.3
113B	Western	5,467	320	5	102	97	SAP DH	15	3,163	47,498	8.7	42,819	7.8
113 C	Western	5,415	347	6	193	187	SAP DH	15	2,892	84,083	15.5	73,028	13.5
49 A	Western	7,274	363	13	307	294	SAP DH	15	4,628	179,678	24.7	153,262	21.1
50 A	Western	6,823	397	20	177	157	SAP WYNPK	15	3,901	94,056	13.8	82,188	12.0
61 A1	Western	4,967	275	17	302	285	SAP DH	15	3,022	129,442	26.1	110,234	22.2
61 A2	Western	4,851	326	18	302	284	SAP DH	15	2,500	109,505	22.6	93,677	19.3
62 A	Western	5,096	321	21	330	309	PANS OPS	30	2,780	125,046	24.5	106,684	20.9
73 A	Western	2,835	295	14	245	231	NAO THS	15	733	31,634	11.2	27,994	9.9
115	Western	4,294	317	16	313	297	PANS OPS	30	2,012	89,132	20.8	76,474	17.8
26 A1	City Core	3,633	245	15	215	200	NAO AUS SQ	15	1,926	59,712	16.4	51,723	14.2
26 A2	City Core	4,079	263	17	189	172	NAO AUS SQ	15	2,229	59,265	14.5	51,644	12.7
27	City Core	5,541	330	15	217	202	NAO AUS SQ	15	3,159	97,537	17.6	84,232	15.2
28 A	City Core	8,330	411	6	217	211	NAO MACQPL	15	5,297	133,838	16.1	116,054	13.9
28 C	City Core	4,364	267	4	330	326	PANS OPS	30	2,488	117,502	26.9	99,972	22.9
29 C	City Core	3,085	240	3	330	327	PANS OPS	30	1,423	69,624	22.6	59,561	19.3
34 A	City Core	8,333	363	20	216	196	SAP WYN PARK	15	5,682	124,549	14.9	108,377	13.0
43 B	City Core	3,692	239	18	271	253	NAO PSM	15	2,036	78,882	21.4	67,609	18.3
44 A	City Core	6,759	372	13	315	302	NAO PSM	15	4,040	182,246	27.0	155,050	22.9
46	City Core	5,659	361	9	193	184	SAP WYN PARK	15	3,024	86,322	15.3	75,038	13.3
55 A1	City Core	4,299	291	13	203	190	SAP MP	15	2,224	65,994	15.4	57,349	13.3
54 A	City Core	6,935	400	13	200	187	NAO MP	15	3,987	113,622	16.4	98,436	14.2

B\_14 Continued

Commercial Development Capacity of identified sites

Map Reference	Precinct	Site Area (sqm)	Site Perimeter (m)	Highest Site Ground Level (RL AHD)	Average Maximum Potential Height (RL AHD)	Maximum Height Above Ground (m)	Prevailing Height Control	Roof/ Construction Zone (m)	Tower Zone Area (sqm)	Total Floor Space High (sqm)	Floor Space Ratio High (X:1)	Total Floor Space Moderate (sqm)	Floor Space Ratio Moderate (X:1)
		SA	SP	SGL	AMPH	MH_AGL	PHC	RCZ	TZA	TOTAL_FS_high		TOTAL_FS_mod	
55 A2	City Core	4,422	320	19	170	151	SAP MP	15	2,119	51,702	11.7	45,614	10.3
76 D	City Core South	2,393	212	22	241	219	NAO THS	15	952	34,465	14.4	30,046	12.6
89	City Core South	2,180	189	19	202	183	NAO THS	15	927	28,051	12.9	24,606	11.3
96	Midtown	4,429	299	24	233	209	SAP HP	15	2,295	74,775	16.9	64,693	14.6
116 B	Midtown	3,366	277	20	307	287	SAP BELPK	15	1,405	64,571	19.2	55,567	16.5
122	Midtown	2,046	199	22	311	289	PANS OPS	30	710	32,529	15.9	28,221	13.8
123 A	Midtown	2,685	287	21	305	284	SAP BELPK	15	646	33,699	12.6	29,603	11.0
123 B	Midtown	2,174	241	21	309	288	PANS OPS	30	501	25,637	11.8	22,607	10.4
124 B	Midtown	8,349	503	26	203	177	SAP HP	15	4,584	113,209	13.6	99,013	11.9
127 A	Midtown	4,802	410	21	241	220	SAP BELPK	15	1,779	65,906	13.7	57,604	12.0
136 A	Southern	1,745	201	4	257	253	PANS OPS	30	396	18,284	10.5	16,249	9.3
136 B	Southern	1,661	193	6	255	249	PANS OPS	30	373	17,076	10.3	15,196	9.1
136 C	Southern	1,322	161	3	246	243	PANS OPS	30	288	13,071	9.9	11,665	8.8
136 D	Southern	1,426	170	4	245	241	PANS OPS	30	325	14,427	10.1	12,853	9.0
137 A	Southern	5,528	323	9	223	214	SAP BELPK	15	3,201	104,025	18.8	89,587	16.2
138	Southern	2,624	205	4	221	217	SAP BELPK	15	1,236	42,666	16.3	36,977	14.1
168 A1	South Ultimo	7,804	360	15	243	228	PANS OPS	30	5,180	133,065	17.1	115,073	14.7
168 A2	South Ultimo	8,327	373	14	243	229	PANS OPS	30	5,598	135,626	16.3	117,530	14.1
161 A1	South Ultimo	4,537	284	7	243	236	PANS OPS	30	2,525	85,565	18.9	73,683	16.2
161 A2	South Ultimo	3,667	251	5	243	238	PANS OPS	30	1,918	66,390	18.1	57,266	15.6
166 A	South Ultimo	2,159	188	7	243	236	PANS OPS	30	907	32,726	15.2	28,457	13.2

B\_14 Continued

Commercial Development Capacity of identified sites

Map Reference	Precinct	Site Area (sqm)	Site Perimeter (m)	Highest Site Ground Level (RL AHD)	Average Maximum Potential Height (RL AHD)	Maximum Height Above Ground (m)	Prevailing Height Control	Roof/ Construction Zone (m)	Tower Zone Area (sqm)	Total Floor Space High (sqm)	Floor Space Ratio High (X:1)	Total Floor Space Moderate (sqm)	Floor Space Ratio Moderate (X:1)
		SA	SP	SGL	AMPH	MH_AGL	PHC	RCZ	TZA	TOTAL_FS high		TOTAL_FS mod	
166 B	South Ultimo	2,815	215	5	243	238	PANS OPS	30	1,351	47,650	16.9	41,220	14.6
162 A1	South Ultimo	3,967	253	11	243	232	PANS OPS	30	2,200	73,281	18.5	63,157	15.9
162 A2	South Ultimo	3,849	258	11	243	232	PANS OPS	30	2,045	68,716	17.9	59,307	15.4
162 A3	South Ultimo	3,744	248	11	243	232	PANS OPS	30	2,018	67,622	18.1	58,335	15.6
165 A1	South Ultimo	5,593	308	9	243	234	PANS OPS	30	3,386	111,887	20.0	96,129	17.2
165 A2	South Ultimo	5,727	307	13	243	230	PANS OPS	30	3,530	114,144	19.9	98,082	17.1
165 A3	South Ultimo	5,121	290	15	243	228	PANS OPS	30	3,057	98,537	19.2	84,786	16.6
165 B	South Ultimo	2,206	205	15	243	228	PANS OPS	30	821	29,572	13.4	25,880	11.7
163	South Ultimo	2,409	202	9	243	234	PANS OPS	30	1,051	37,260	15.5	32,367	13.4
164 A1	South Ultimo	3,192	225	10	243	233	PANS OPS	30	1,650	56,034	17.6	48,396	15.2
164 A2	South Ultimo	3,561	368	11	243	232	PANS OPS	30	873	36,544	10.3	32,525	9.1
164 A3	South Ultimo	3,592	280	15	243	228	PANS OPS	30	1,607	55,175	15.4	47,946	13.3
164 B	South Ultimo	2,533	207	16	243	227	PANS OPS	30	1,133	38,728	15.3	33,662	13.3
151	Southern	2,126	197	12	243	231	PANS OPS	30	803	29,177	13.7	25,502	12.0
152	Southern	3,051	230	5	287	282	PANS OPS	30	1,469	61,345	20.1	52,695	17.3
153A	Southern	9,786	562	13	243	230	PANS OPS	30	5,547	141,698	14.5	123,498	12.6
149	Southern	2,925	241	15	243	228	PANS OPS	30	1,252	43,461	14.9	37,829	12.9
156 A	Southern	5,923	339	9	146	137	SAP BELPK	15	3,466	72,382	12.2	63,686	10.8
158	Southern	2,761	253	10	243	233	PANS OPS	30	993	36,856	13.3	32,262	11.7
156 A	Southern	5,923	339	9	146	137	SAP BELPK	15	3,466	72,382	12.2	63,686	10.8
158	Southern	2,761	253	10	243	233	PANS OPS	30	993	36,856	13.3	32,262	11.7

**Part 3 - Comparison with existing controls**

The potential growth scenarios are compared with existing built floor space from the Floor Space Employment Study and existing maximum floor space controls and the higher value used in each case.

The codes used for the comparison study are described in B\_15.

A precinct summary is shown in B\_16 and a full comparison is presented in B\_17.

**B\_15**

Description of Codes for Existing Floor Space Controls

Code	Description
EMFS	Existing Maximum Floor Space (from SLEP 2012 controls)
FSES_FS	Floor Space Counted in the Floor Space Employment Survey (2012)

**B\_16**

Precinct Summary - Comparison of Capacity to Floor Space Employment Survey (FSES) and Tier 1/2 Floor Space

Precinct	TOTAL_FS High above FSES_FS	TOTAL_FS High above EMFS	TOTAL_FS Moderate above FSES_FS	TOTAL_FS Moderate above EMFS
City Core	485,452	299,344	330,332	150,475
City Core South	40,147	8,142	7,677	3,723
Western	604,079	484,910	459,054	340,483
Midtown	381,398	36,531	103,693	13,137
Southern	582,561	219,582	354,188	135,653
South Ultimo	1,112,250	809,444	869,308	637,455
<i>Total</i>	3,205,888	1,857,953	2,124,252	1,280,927

**B\_17**

Comparison of Capacity to Floor Space Employment Survey (FSES) and Existing Maximum Floor Space (EMSF)

Map Reference	Precinct	Existing Floor Space from FSES (FSES_FS)	Existing FSR from FSES	Existing Maximum Floor Space (EMFS)	Existing Maximum FSR	TOTAL_FS High above FSES_FS	TOTAL_FS High above EMFS	TOTAL_FS Moderate above FSES_FS	TOTAL_FS Moderate above EMFS
011 A	Western	75,660	9.63	86,460	11	+76,757	+65,957	+55,447	+44,647
48	Western	67,235	15.92	46,464	11	-18,178	+2,593	-23,936	-3,165
113B	Western	37,210	6.81	38,269	7	+10,288	+9,229	+5,609	+4,550
113 C	Western	51,870	9.58	37,905	7	+32,213	+46,178	+21,158	+35,123
49 A	Western	99,122	13.63	80,014	11	+80,556	+99,664	+54,140	+73,248
50 A	Western	55,258	8.1	75,053	11	+38,798	+19,003	+26,930	+7,135
61 A1	Western	40,705	8.2	54,637	11	+88,737	+74,805	+69,529	+55,597
61 A2	Western	40,705	8.39	53,361	11	+68,800	+56,144	+52,972	+40,316
62 A	Western	11,465	2.25	56,056	11	+113,581	+68,990	+95,219	+50,628
73 A	Western	11,465	4.04	31,185	11	+20,169	+449	+16,529	-3,191
115	Western	14,953	3.48	47,234	11	+74,179	+41,898	+61,521	+29,240
26 A1	City Core	48,437	13.33	49,954	13.75	+11,275	+9,758	+3,286	+1,770
26 A2	City Core	48,437	11.87	56,086	13.75	+10,828	+3,179	+3,207	-4,443
27	City Core	39,347	7.1	76,189	13.75	+58,190	+21,348	+44,885	+8,043
28 A	City Core	74,407	8.93	114,538	13.75	+59,431	+19,300	+41,647	+1,516
28 C	City Core	32,656	7.48	60,005	13.75	+84,846	+57,497	+67,316	+39,967
29 C	City Core	38,162	12.37	42,419	13.75	+31,462	+27,205	+21,399	+17,142
34 A	City Core	110,032	13.2	114,579	13.75	+14,516	+9,970	-1,656	-6,202
43 B	City Core	40,797	11.05	50,765	13.75	+38,086	+28,117	+26,812	+16,844
44 A	City Core	79,277	11.73	92,936	13.75	+102,969	+89,310	+75,773	+62,114
46	City Core	95,765	16.92	77,811	13.75	-9,443	+8,511	-20,727	-2,773
54 A	City Core	62,087	8.95	95,356	13.75	+51,535	+18,266	+36,348	+3,079

B\_17 Continued

Comparison of Capacity to Floor Space Employment Survey (FSES) and Existing Maximum Floor Space (EMSF)

Map Reference	Precinct	Existing Floor Space from FSES (FSES_FS)	Existing FSR from FSES	Existing Maximum Floor Space (EMFS)	Existing Maximum FSR	TOTAL_FS High above FSES_FS	TOTAL_FS High above EMFS	TOTAL_FS Moderate above FSES_FS	TOTAL_FS Moderate above EMFS
55 A1	City Core	47,690	11.09	59,111	13.75	+18,304	+6,882	+9,659	-1,762
55 A2	City Core	47,690	10.78	60,803	13.75	+4,012	-9,101	-2,076	-15,188
76 D	City Core South	22,369	9.35	26,323	11	+12,096	+8,142	+7,677	+3,723
89	City Core South	27,943	12.82	29,982	13.75	+28,051	-1,930	-3,337	-5,375
96	Midtown	44,039	9.94	60,912	13.75	+74,775	+13,863	+20,654	+3,781
116 B	Midtown	42,611	12.66	46,293	13.75	+51,650	+18,278	+12,956	+9,274
122	Midtown	5,649	2.76	28,139	13.75	+32,529	+4,390	+22,572	+82
123 A	Midtown	10,358	3.86	36,927	13.75	+28,050	-3,228	+19,245	-7,324
123 B	Midtown	4,575	2.1	29,899	13.75	+15,279	-4,262	+18,032	-7,292
124 B	Midtown	88,778	10.63	114,824	13.75	+113,209	-1,615	+10,235	-15,811
127 A	Midtown	78,212	16.29	66,042	13.75	+65,906	-136	-20,608	-8,438
120 C	Southern	27,188	5.12	55,490	10.45	+83,980	+28,491	+45,687	+17,386
135	Southern	5,963	4.9	12,058	9.9	-13,831	+1,298	+5,870	-225
136 A	Southern	13,535	7.76	17,276	9.9	+12,321	+1,008	+2,714	-1,027
136 B	Southern	5,740	3.46	16,444	9.9	+3,541	+632	+9,456	-1,248
136 C	Southern	2,571	1.94	13,088	9.9	+7,331	-17	+9,094	-1,423
136 D	Southern	2,239	1.57	14,117	9.9	+11,856	+310	+10,614	-1,264
137 A	Southern	27,215	4.92	54,727	9.9	+101,786	+49,297	+62,372	+34,860
138	Southern	7,679	2.93	25,978	9.9	+42,666	+16,689	+29,298	+10,999
168 A1	South Ultimo	8,167	1.05	31,216	4	+133,065	+101,849	+106,906	+83,857
168 A2	South Ultimo	8,167	.98	33,308	4	+135,626	+102,318	+109,363	+84,222
161 A1	South Ultimo	8,167	1.8	18,148	4	+85,565	+67,417	+65,516	+55,535

B\_17 Continued

Comparison of Capacity to Floor Space Employment Survey (FSES) and Existing Maximum Floor Space (EMSF)

Map Reference	Precinct	Existing Floor Space from FSES (FSES_FS)	Existing FSR from FSES	Existing Maximum Floor Space (EMFS)	Existing Maximum FSR	TOTAL_FS High above FSES_FS	TOTAL_FS High above EMFS	TOTAL_FS Moderate above FSES_FS	TOTAL_FS Moderate above EMFS
161 A2	South Ultimo	8,167	2.23	14,668	4	+58,223	+51,722	+49,099	+42,598
166 A	South Ultimo	3,907	1.81	8,636	4	+24,559	+24,090	+24,550	+19,821
166 B	South Ultimo	15,500	5.51	14,075	5	+43,743	+33,575	+25,720	+27,145
162 A1	South Ultimo	8,205	2.07	39,273	9.9	+73,281	+34,008	+54,952	+23,884
162 A2	South Ultimo	8,205	2.13	38,105	9.9	+60,511	+30,611	+51,102	+21,202
162 A3	South Ultimo	8,205	2.19	37,066	9.9	+59,417	+30,557	+50,130	+21,269
165 A1	South Ultimo	24,941	4.46	27,965	5	+111,887	+83,922	+71,188	+68,164
165 A2	South Ultimo	24,941	4.35	28,635	5	+89,203	+85,509	+73,141	+69,447
165 A3	South Ultimo	24,941	4.87	25,605	5	+73,596	+72,932	+59,845	+59,181
165 B	South Ultimo	523	.24	11,030	5	+4,631	+18,542	+25,357	+14,850
163	South Ultimo	6,201	2.57	23,849	9.9	+36,737	+13,410	+26,166	+8,518
164 A1	South Ultimo	21,425	6.71	31,601	9.9	+56,034	+24,433	+26,971	+16,795
164 A2	South Ultimo	21,425	6.02	35,257	9.9	+15,119	+1,287	+11,100	-2,732
164 A3	South Ultimo	21,425	5.96	35,564	9.9	+33,750	+19,611	+26,521	+12,382
164 B	South Ultimo	21,981	8.68	25,077	9.9	+17,303	+13,651	+11,681	+8,585
151	Southern	10,503	4.94	21,047	9.9	+7,196	+8,130	+14,999	+4,454
152	Southern	10,470	3.43	30,205	9.9	+50,842	+31,140	+42,225	+22,490
153A	Southern	41,634	4.25	96,881	9.9	+131,228	+44,816	+81,864	+26,616
149	Southern	9,587	3.28	28,958	9.9	+43,461	+14,504	+28,242	+8,872
156 A	Southern	55,498	9.37	58,638	9.9	+49,497	+13,744	+8,188	+5,048
158	Southern	28,696	10.39	27,334	9.9	+36,856	+9,522	+3,566	+4,929
158	Southern	28,696	10.39	27,334	9.9	+36,856	+9,522	+3,566	+4,929



## Conclusion

The strategy of increasing heights and floor space ratios creates opportunities for additional floor space. Tested sites that will yield higher amounts of floor space than existing maximum floor space controls could add between 1.2-1.8 million sqm of development potential. This could equate to between 2.1-3.2 million square metres of additional floor space being added above the existing built floor space in a maximum efficiency scenario, the likely addition being in the order of half this amount.

## Limitations

The capacity study:

- is not a feasibility analysis
- assumes maximum potential amalgamation of sites
- does not reflect growth potential for all sites
- does not assess design merit of notional tower forms
- includes most but not all Special Character Area and View Corridor setbacks
- reflects commercial building efficiencies and setbacks

Notes:

- Residential buildings will have higher height efficiency but lower horizontal sectional efficiency. They will also have significantly lower maximum tower zone area and higher side and rear setbacks. Overall this means that the amount of available floor space will be significantly less than reflected in this report for a moderate-high proportion of predominantly residential developments.
- 15-30% building articulation may result in relatively unarticulated building forms